

BM950

Heavy Duty



- Silent motor.
- Control unit that allows the motor to be fixed to the top or bottom of the curtain.
- The motor automatically sets limits.
- The curtain can be opened manually in case of power loss.
- The motor can be started by manually moving the curtains.
- Radio receiver, switch and/or integrated network control.
- Compatible with smart system.
- It has intermediate functions.
- Smooth starting and braking.
- The curtain holder has a traditional and ripplefold curtain design.
 - o Durable textile belt system.
 - o Can be curved.
 - o 5 years warranty.
 - o Compatible with intelligent system with Neo interface (control 4, google assistant, alexa amazon, etc).

MOTOR SPECS

DIMENSIONS	344 x 69 x 57mm
WEIGHT	1.5 Kg
VOLTAGE	110V ac
AMPERAGE	1.5 Amps
FREQUENCY	50/60Hz
SPEED	0.16m per second
TORQUE	2Nm



MOTOR ANATOMY

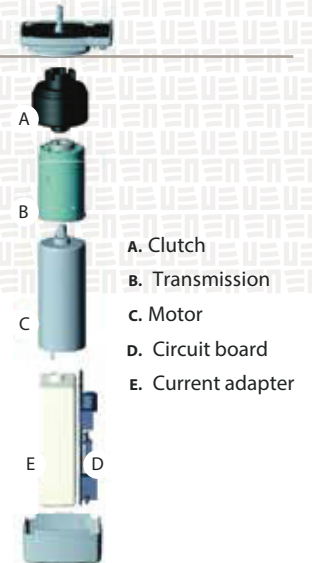
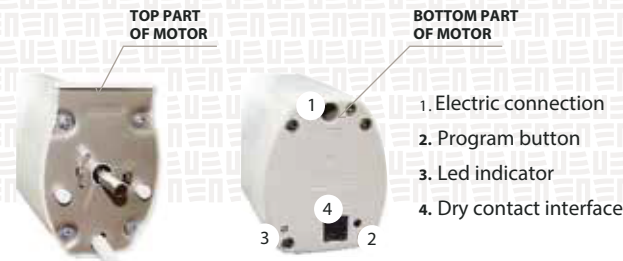

LOAD CAPACITY

		MODO CONTROL INALÁMBRICO			
		4M	6M	8M	12M
	×	60 Kg	50 Kg	40 Kg	30 Kg
	R400	50 Kg	40 Kg	30 Kg	20 Kg
	R2000	50 Kg	40 Kg	30 Kg	20 Kg
	R400 x 2	30 Kg	20 Kg	×	×

CONNECTION DIAGRAM

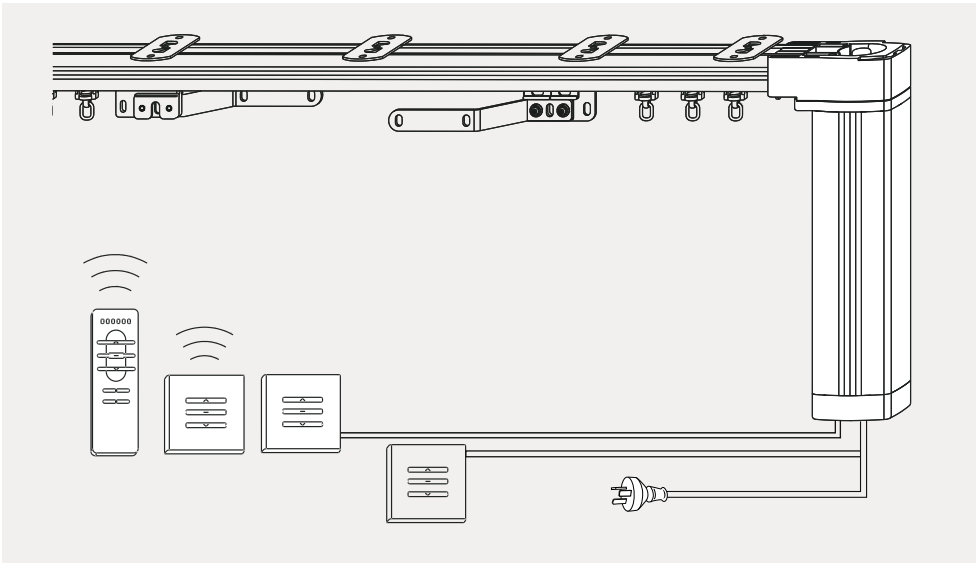

MOTORIZED RAILSYSYSTEM PIECES

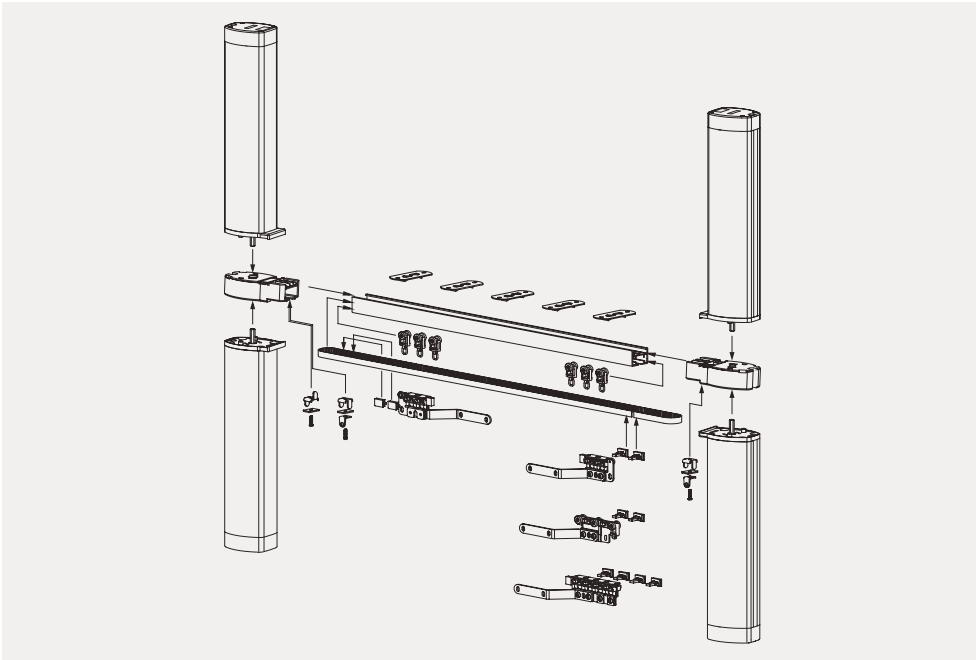

SUPPORT SEPARATION

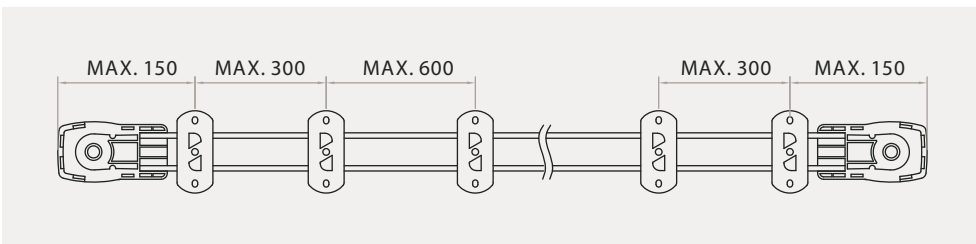

ACCESSORIES

RAIL
RAM-426
RAM-580



TEXTILE BAND
BTM-12

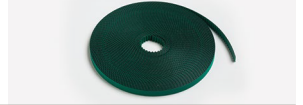

MASTER CARRIER
MIDM-101



RIPPLEFOLD MASTER CARRIER
MRLM-103



MOTOR CONTROL UNIT
UMC-950



END CAP
TFM-001



SILENT CARRIER
CSM-1000



RIPPLEFOLD CARRIER
CRLM-600



RAIL CONNECTOR
RAM-UNIÓN



CEILING BRACKET
STM-003



CIRCULAR BRACKET
SCM-004



WALL BRACKET
SPM-002



INSTALLATION DIMENSIONS

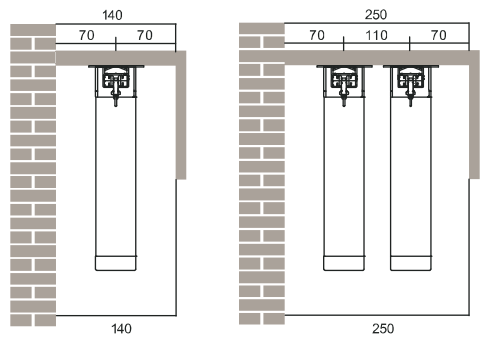

UNIDAD DE MEDIDA: mm



EE.UU
Baja Contract
9927 Via de la Amistad
San Diego, CA 92154

EMAIL
info@bajacontract.com

(800) 663-91-28

bajacontract.com